

**ALBERTA GOVERNMENT SERVICES  
LAND TITLES OFFICE**

IMAGE OF DOCUMENT REGISTERED AS:

**191043624**

**ORDER NUMBER: 36823721**

**ADVISORY**

This electronic image is a reproduction of the original document registered at the Land Titles Office. Please compare the registration number on this coversheet with that on the attached document to ensure that you have received the correct document. Note that Land Titles Staff are not permitted to interpret the contents of this document.

Please contact the Land Titles Office at (780) 422-7874 if the image of the document is not legible.

**CAVEAT**

TO THE REGISTRAR OF THE ALBERTA LAND TITLES OFFICE

*Rec*

TAKE NOTICE that **S.R. HOMEOWNERS ASSOCIATION** of Edmonton, in the Province of Alberta, and **SUNSET PROPERTIES INC.**, of Edmonton, in the Province of Alberta (together the "Caveator"), each claim an interest under and by virtue of a Restrictive Covenant in writing, dated January 18, 2019, and made between **SUNSET PROPERTIES INC.**, as registered owner, and the Caveator whereby the said registered owner and the Caveator agreed, all in accordance with the terms of the said Restrictive Covenant, a true copy of which is attached to and forms part of this Caveat, in the lands described as follows:

See Schedule "A" attached hereto.

standing in the register in the name of **SUNSET PROPERTIES INC.**, and the Caveator forbids the registration of any person as transferee or owner of, or of any instrument affecting the said estate or interest, unless the instrument or Certificate of Title, as the case may be, is expressed to be subject to the Caveator's claim.

THE CAVEATOR DESIGNATES 900, 10310 Jasper Avenue, Edmonton, AB, T5J 1Y8, as the place at which notices and proceedings relating hereto may be served.

Dated this 18th day of January, 2019.

**S.R. HOMEOWNERS ASSOCIATION**  
 Corporate  
 PER: [Signature]  
 PER: [Signature]

**SUNSET PROPERTIES INC.**  
 Corporate  
 Seal  
 PER: [Signature]  
 PER: [Signature]

**AFFIDAVIT IN SUPPORT OF CAVEAT**

I, KAREN ALBARDA, of the City of Edmonton, in the Province of Alberta, MAKE OATH AND SAY AS FOLLOWS:

1. That I am Agent for the Caveator.
2. I believe that the said Caveator has a good and valid claim upon the said land and I say that this Caveat is not being filed for the purpose of delaying or embarrassing any person interested in or proposing to deal therewith.

SWORN BEFORE ME Tanya Eklund  
 at the City of Edmonton, in the  
 Province of Alberta, this 18th  
 Day of January, A.D. 2019  
Tanya Eklund  
 A COMMISSIONER FOR OATHS IN AND  
 FOR THE PROVINCE OF ALBERTA

)  
 ) [Signature]  
 ) KAREN ALBARDA  
 )

**SCHEDULE "A"**

PLAN 181 2037  
BLOCK 23  
LOTS 102 - 122 INCLUSIVE  
EXCEPTING THEREOUT ALL MINES AND MINERALS

PLAN 181 2037  
BLOCK 41  
LOTS 16 - 18 INCLUSIVE  
EXCEPTING THEREOUT ALL MINES AND MINERALS

PLAN 181 2037  
BLOCK 42  
LOTS 15 - 43 INCLUSIVE  
EXCEPTING THEREOUT ALL MINES AND MINERALS

**THIS RESTRICTIVE COVENANT**

MADE AS OF THIS 18th day of January, 2019.

BETWEEN:

**SUNSET PROPERTIES INC.,**  
a body corporate incorporated under the laws of the Province of Alberta  
(hereinafter called the "Grantor/Grantee")

OF THE FIRST PART

- and -

**S. R. HOMEOWNERS ASSOCIATION,**  
a society incorporated under the *Societies Act* of Alberta  
with registered office at 900, 10310 Jasper Avenue  
in the City of Edmonton, in the Province of Alberta, T5J 1Y8  
(hereinafter called the "Grantee")

OF THE SECOND PART

**RESTRICTIVE COVENANT**

WHEREAS:

- a. The Grantor/Grantee is the registered owner of the Dominant Lands and the Servient Lands described in Schedule "A" hereto situate in the Town of Cochrane.
- b. The Grantor/Grantee intends to impose a scheme of mutually enforceable restrictions with respect to the use and improvements on the Lands in order to preserve the integrity of the Development.

NOW THEREFORE:

The Grantor/Grantee as registered owner of the Servient Lands described in Schedule "A" does grant and the Grantor does hereby declare, establish, impose and annex to the Servient Lands and each and every portion thereof for the benefit of the Dominant Lands, the following stipulations, restrictions, guidelines and provisions to run with the Lands and be binding upon the owners from time to time of the Lots:

1. In this Restrictive Covenant, including the preamble, the following words and expressions shall have the meaning herein set forth:
  - a. "**Architectural Committee**" means a committee established by the Grantor/Grantee for so long as the Grantor/Grantee remains an Owner, and thereafter established by the Homeowners Association;
  - b. "**Development**" means the residential subdivision plan within which the Lots are located;
  - c. "**Dominant Lands**" means the leasehold and easement interests of the Homeowner's Association, granted to the Homeowner's Association the lands described in Schedule "A" hereto;

- d. **“Dwelling”** means any residential dwelling constructed on any of the Lots;
  - e. **“Guidelines”** means the Architectural and Construction Guidelines attached hereto as Schedule “B” and as amended from time to time by the Architectural Committee;
  - f. **“Homeowners Association”** means the S.R. Homeowners Association;
  - g. **“Lands”** means the lands described in Schedule ‘A’ hereto;
  - h. **“Lot”** means one of the lots described in Schedule ‘A’ hereto and any further subdivision of such lots;
  - i. **“Owner”** means a registered owner in fee simple of a Lot;
  - j. **“Restrictions”** means the provisions, restrictions and stipulations contained in Paragraph 2 of this Restrictive Covenant;
  - k. **“Restrictive Covenant”** means this agreement as the same may be amended from time to time and the expressions “herein”, “hereof”, “hereto”, “above”, “below”, and similar expressions if used in any article, section or paragraph of this agreement refer to this agreement including the schedules hereto and do not refer solely to a particular article, section or paragraph unless specifically stated herein;
  - l. **“Servient Lands”** means the lands described as such in Schedule ‘A’ hereto.
2. For each of the Lots comprising the Servient Lands, for the benefit of the Dominant Lands, the following restrictions, stipulations and provisions are to run with the Lands, namely:
- a. No motor homes, recreational vehicles, trailers, boats or similar vehicles shall be stored for any period exceeding seven (7) days or for any period aggregating fourteen (14) days in a twelve month period on the front driveway, nor on the side yard, nor on any driveway of any building on any of the Lots, unless within an enclosure approved by the Architectural Committee, or as required by Municipal Bylaw as amended from time to time.
  - b. No satellite dishes shall be constructed, installed, placed, kept or maintained on any roof, front or side yard of any Dwelling, unless first approved by the Architectural Committee;
  - c. No radio or television aerials or antenna of any kind shall be erected, constructed or placed on any Dwelling or on any of the Lots, unless first approved by the Architectural Committee and unless the said aerial or antenna is a single unit incorporated into the structure of the Dwelling;
  - d. No construction of the Dwelling may commence unless the building plans have been approved by the Architectural Committee;
  - e. No dwelling may be constructed unless said Dwelling conforms with the Guidelines attached hereto as Schedule “B”;

- f. The driveway width for all semi-detached dwellings with a front attached single garage will be limited to the width of the garage only.
  - g. Secondary/accessory suites are prohibited on all front drive semi-detached dwellings.
3. If any of the Restrictions herein or the application thereof to any part or any circumstances shall be held by any Court of competent jurisdiction to be invalid or unenforceable to any extent, then such Restriction shall be severed from the remainder of this Restrictive Covenant, and the remainder of this Restrictive Covenant or application of such Restriction to a party or circumstance other than those to which it is held invalid or unenforceable shall not be affected thereby and each of the remaining Restrictions of this Restrictive Covenant shall be valid and enforceable to the fullest extent permitted by the law.
  4. This Restrictive Covenant is in addition to the requirements of the municipal or other government authorities having jurisdiction in respect of the use of the Lands, and nothing contained herein shall be construed as permitting or authorizing anything which is prohibited, controlled or regulated by any statute, bylaw, regulation or like enactment having the force of law and having application to the lands.
  5. Nothing herein shall require or oblige the Grantee to enforce this Restrictive Covenant or render the Grantee liable for the failure of any of the Owners from time to time of the Lots to adhere to or conform with the Restrictions contained in this Restrictive Covenant, it being the intention to attach to each of the Lots and the Owners thereof the obligation for compliance with this Restrictive Covenant.
  6. The Restrictions contained in this Restrictive Covenant shall be binding upon and enure to the benefit of the Owner from time to time of each of the Lots and the Grantee and the restrictions herein shall run with the Lands and each of the Lots.

IN WITNESS WHEREOF these presents have been executed by each of the parties hereto the day and year first above written under its corporate seal and by the hands of its officers duly authorized in that behalf.

SUNSET PROPERTIES INC.  
Per:  \_\_\_\_\_  
Per: \_\_\_\_\_ (seal)

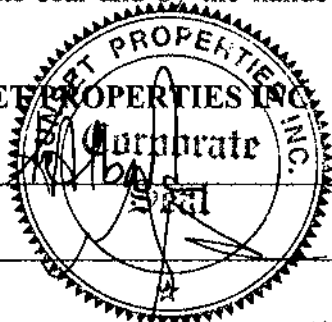

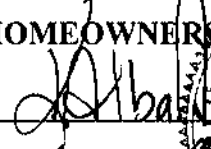
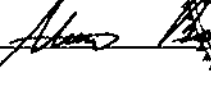
S. R. HOMEOWNERS ASSOCIATION  
Per:  \_\_\_\_\_  
Per:  \_\_\_\_\_ (seal)

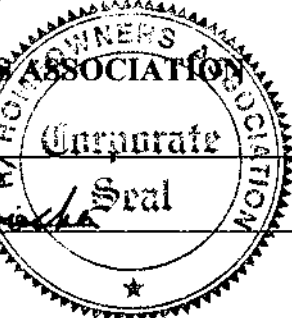

**SCHEDULE "A"**  
**TO RESTRICTIVE COVENANT AGREEMENT**

---

The Current Lots are legally described as follows, all being lots shown on the subdivision plan registered as Plan No. 181 2037, namely:

Block 23, Lots 102 to 122 inclusive

Block 41, Lots 16 to 18 inclusive

Block 42, Lots 15 to 43 inclusive

**SCHEDULE "B"**

**ARCHITECTURAL AND CONSTRUCTION GUIDELINES**

---



# Sunset Ridge

— IN COCHRANE BY —

## PHASE 21A ARCHITECTURAL GUIDELINES

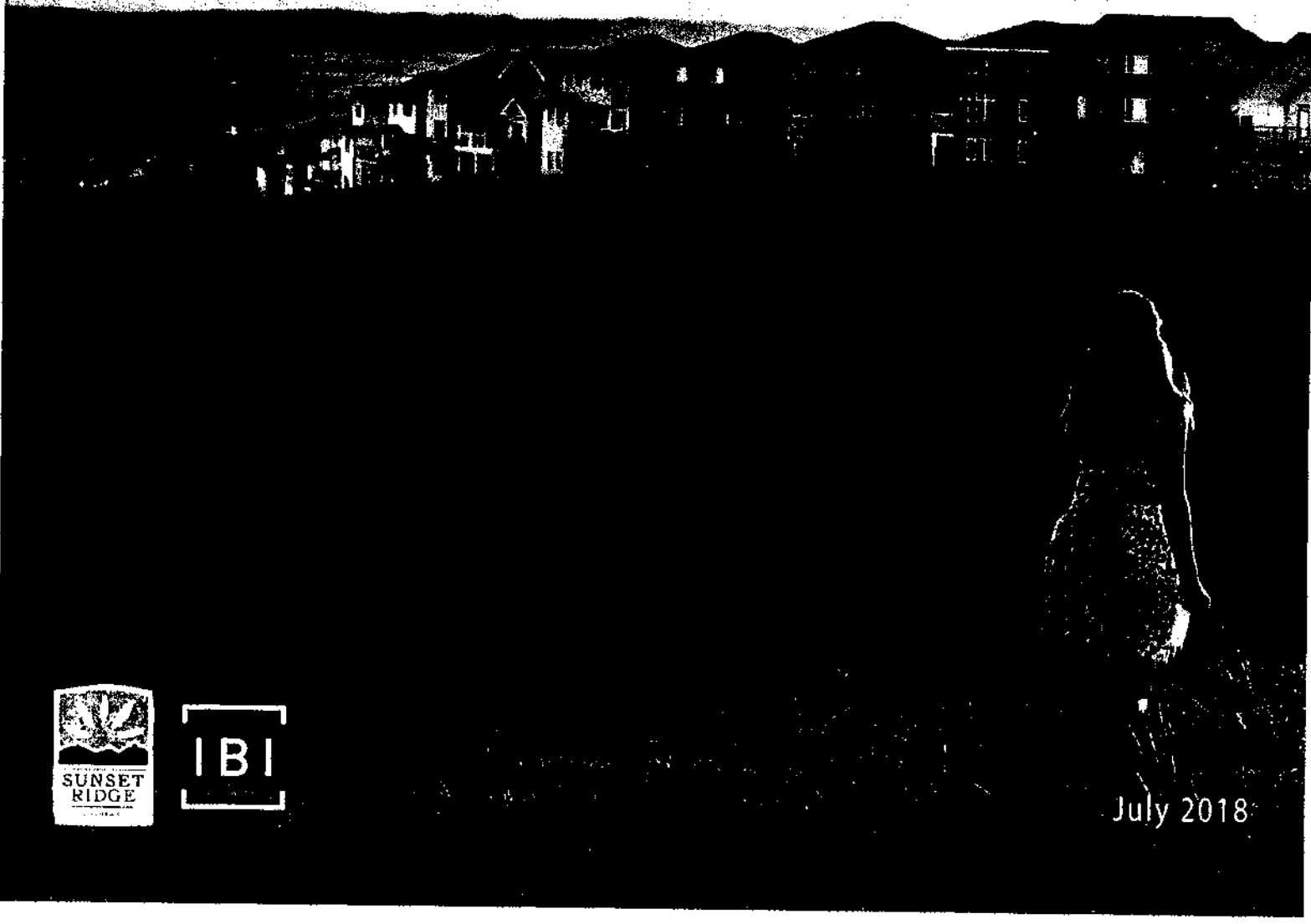

July 2018



## TABLE OF CONTENTS

1.	INTRODUCTION	1
1.1	Architectural Guidelines	2
1.2	Intent and Theme	2
2.	LAND USE ZONING	3
2.1	Land Use Bylaw	3
2.2	Zoning Regulations	3
2.3	Minimum Home Sizes	3
3.	SITING	4
3.1	House Placement	4
3.2	Front Yard Setbacks	4
3.3	Maximum Side Yards	4
	3.3.1 Interior Lots	4
	3.3.2 Corner Lots	4
	3.3.3 Amenity Lots	5
3.4	Lot Grading	6
4.	ARCHITECTURAL DESIGN	7
4.1	Proposed Housing Product	7
4.2	Repetition	7
4.3	Architectural Theme & Style	7
	4.3.1 Craftsman/Arts and Crafts	8
	4.3.2 Prairie	9
4.4	Building Form and Massing	10
	4.4.1 Roof Design and Pitch	11
	4.4.2 Two Storey Front Massing	11
	4.4.3 Corner Lots	11
	4.4.4 Front Porches	12
	4.4.5 Rear Elevations	13
	4.4.6 Exterior Decks and Patios	13
	4.4.7 Chimneys	13
	4.4.8 Retaining Walls	13
	4.4.9 Columns	14
	4.4.10 Gable Treatment	14
5.	BUILDING MATERIALS AND COLOURS	15
5.1	Primary Wall Materials	15
5.2	Exterior Colours	16
5.3	Masonry	16
5.4	Trim, Fascia, and Soffit	17





## TABLE OF CONTENTS

5.5	Windows	17
5.6	Roofing	18
5.7	Roof Hardware	18
5.8	Front Doors	18
5.9	Garage Doors	19
5.10	Railings	19
5.11	Driveways and Sidewalks	20
5.12	Front Steps	20
5.13	Parging	20
5.14	Lighting	20
6.	ADDITIONAL REQUIREMENTS	21
6.1	Recreation and Commercial Vehicles	21
6.2	Satellite Dishes	21
6.3	Solar Panels	
7.	LANDSCAPING	22
7.1	Fencing	22
7.2	Front Yard Landscaping	22
7.3	Fire Pits and Outdoor Fireplaces	22
8.	APPROVAL PROCESS	23
8.1	Preliminary Review	23
8.2	Formal Application Submission	23
8.3	Final Inspection	23
8.4	Schedule of Applicable Fees	23
9.	CONSTRUCTION REGULATIONS	24
9.1	Material and Equipment Storage	24
9.2	Use of Site	24
9.3	Vehicles and Parking	24
9.4	Other Notes	24
10.	DISCRETION	25
10.1	No Right to Enforce	25
10.2	Right to Amend	25
10.3	No Trespassing	25
11.	CONTACTS	26
	APPENDIX A: SIDING COLOURS	
	APPENDIX B: FENCING	
	APPENDIX C: SINGLE FAMILY LANED LOTS SIDE YARD ENHANCEMENTS	
	APPENDIX D: FRONT YARD SETBACKS	
	APPENDIX E: LAND USE BYLAW	





## 1. INTRODUCTION

Sunset Ridge is a master planned residential community located in the Town of Cochrane, Alberta. Sunset Ridge is accessed from Highway 22 North and consists of a wide variety of housing options ranging from multifamily homes to starter single family homes to estate single family homes.

These Architectural Guidelines have been written for Phase 21A of Sunset Ridge which consists of 32 Single Family Laned and 21 Single Family Front Drive Semi-Estate homes. The lot sizes will vary. Each lot in Sunset Ridge will be unique and will offer exciting building opportunities.

Traditional inspired homes will be built using modern building materials and techniques. In order to recognize this inspiration, the home styles in Sunset Ridge will be derived by an interpretation of Craftsman, Arts and Crafts and Prairie architecture.

To ensure that the built form remains true to the selected styles, the Architectural Committee has commissioned IBI Group to be the interim Architectural Coordinator for the community. IBI Group will review all home plans submitted by the builders for conformance of these guidelines. This responsibility will be assumed by the Architectural Committee once assigned by the Developer.

**It is recommended that all purchasers obtain a copy of all restrictive covenants prior to signing their home purchase agreements.**

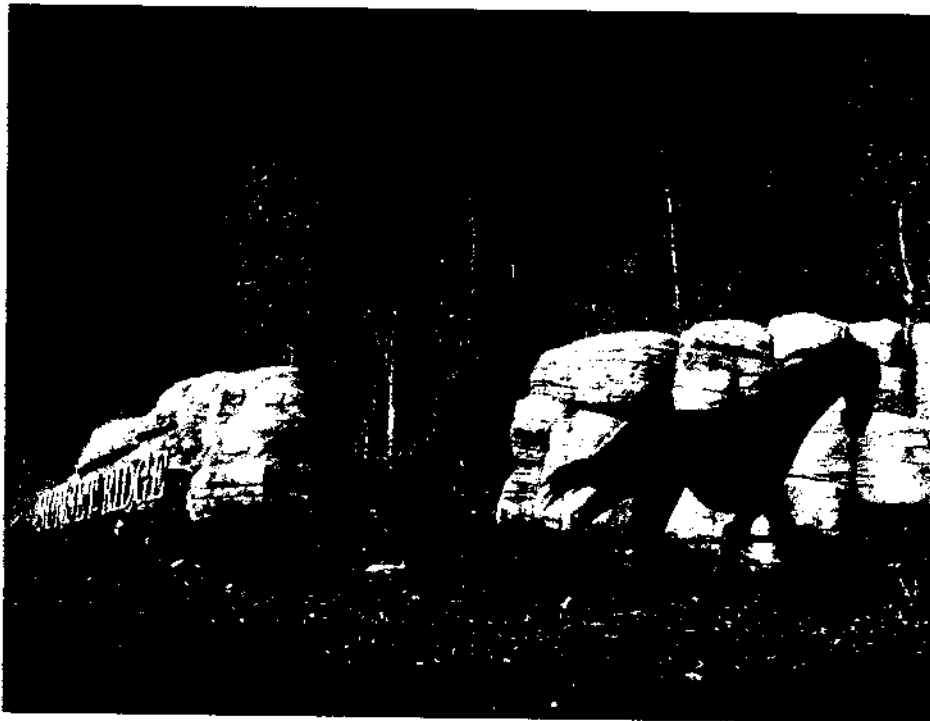



## 1.1 Architectural Guidelines

Architectural Guidelines will be implemented in Sunset Ridge Phase 21A to ensure that all builders will design and build homes to meet standards that are envisioned by the Developer.

The Architectural Guidelines will enhance the integrity of the development and ensure that each home that gets built will add value to the community. The Architectural Guidelines have been prepared to promote a high level of architectural detail, ensure a pleasing building form, and promote an awareness of environmental sustainability.

## 1.2 Intent and Theme

The intent of these guidelines is to create a community of harmony and continuity while maintaining a number of traditional architectural styles to offer variety and flavour.

Architectural styles other than Craftsman, Arts and Crafts, and Prairie will be considered in Sunset Ridge Phase 21A and will be carefully reviewed by the Architectural Committee to ensure that the style will blend with all of the homes in the development.





## 2. LAND USE ZONING

The Architectural Committee will complete a review of all house plans to ensure compliance. An "Approved" stamp must be issued prior to the builder submitting a building permit application to the Town of Cochrane. All construction must comply with the current Town of Cochrane Land Use Bylaw and Alberta Building Code. Construction may only begin upon receipt of a building permit from the Town of Cochrane and a Grade Slip from the Architectural Coordinator. Conformity with the Guidelines does not supersede the required Town of Cochrane approval process.

### 2.1 Land Use Bylaw

Sunset Ridge Phase 21A is comprised of lots which have been zoned R-1 and R-2. All homes will be subject to all land use rules established in the Town of Cochrane Land Use Bylaw. If the Land Use Bylaw is revised at any time, all lots will follow the revised Land Use Bylaw. The land use breakdown is as follow:

#### Single Family - Front Drive Semi-Estate Homes

R-1      Block 23              Lots 102-122

#### Single Family - Laned Homes

R-1      Block 41              Lots 16-18

R-2      Block 42              Lots 15-43

### 2.2 Zoning Regulations

All homes in Sunset Ridge Phase 21A will follow the regulations noted in the appropriate Land Use District in the Town of Cochrane Land Use Bylaw. For convenience, the R-1 and R-2 sections of the Land Use Bylaw along with the General Regulations for Residential Districts can be found in Appendix E.

### 2.3 Minimum Homes Sizes

The Developer has established the following minimum homes sizes for Phase 21A of Sunset Ridge. The minimum floor area is for total floor area above grade and does not include attached garages or any basement floor area.

**Two Storey(Front Drive/Laned):**                      **1,800 ft<sup>2</sup>/1,200 ft<sup>2</sup>**  
**Bungalow & Split Level(Front Drive/Laned):**                      **1,400 ft<sup>2</sup>/850 ft<sup>2</sup>**

The Split Level square footage calculation will include the entire footprint of the home excluding the garage. Split level homes must have the same footprint or larger than the minimum required for a bungalow.



### 3. SITING

#### 3.1 House Placement

Builders are required to choose proper home designs around the approved grading and site topography to take full advantage of views and to maximize lot space. Designers are to take into consideration the lot width, length and shape as houses should be conforming to these sizes. Builders and designers are required to review the Building Grade Plan and Marketing Plan prior to designing the home.

#### 3.2 Front Yard Setbacks

It is the intent in this phase to have varied front yard setbacks to enhance the streetscape. The Architectural Coordinator may adjust the front setback to either push back or pull forward a home 0.5-1.5m on the lot based on lot grades and it's relationship with an approved home on either side.

Laned homes will be permitted setbacks to the minimum town requirement of 4m (to the porch) and front drive semi-estate homes will be permitted to a minimum of 6m (to the garage) and must be staggered 0.5-1.5m, along the street (see Appendix D).

#### 3.3 Maximum Side Yards

##### 3.3.1 Interior Lots

- The preferred combined side yard for all interior lots in Sunset Ridge Phase 21A will be 8' (2.44m) (i.e. a 22' dwelling on a 30' lot). The distance will be measured from the side property line to the foundation wall on both the front and the rear of the dwelling.
- A maximum combined side yard of 10' (3.05m) (i.e. a 28' dwelling on a 38' lot) for all interior lots will be allowed providing that a minimum 2' (0.61) garage offset will be provided (see Example A) or that a minimum 2' (0.61m) porch extension is provided (see Example B). For examples on Single Family Detached lots, please see Appendix C.

##### 3.3.2 Corner Lots

- A maximum combined side yard of 14' (4.27m) will be permitted on corner lots providing that the following conditions have been met;
  - The minimum dwelling width must be 10' (3.05m) less than the lot width noted on the Marketing Plan (i.e. a 28' dwelling on a 38' lot).
  - A minimum 3' (0.91m) wide wraparound porch is provide.
  - Builder may choose to extend the rear deck to meet the 14' (4.27m) combined side yard on corner lots, where possible.



### 3.3.3 Amenity Lots (Block 23, Lots 102-122)

- The preferred combined side yard for all amenity lots will be 8' (2.22m) (i.e. a 30' dwelling on a 38' lot). This distance will be measured from the side property line to foundation wall on both the front and the rear of the dwelling.
- The Developer will permit a maximum combined side yard of 10' (3.05m) (i.e. a 28' dwelling on a 38' lot) for all amenity lots, providing that a minimum 2' (0.61) garage offset will be provided (see Example A) or 2' (0.61m) porch extension is provided (see Example B).
- The Developer will also permit a maximum combined side yard of 12' (3.66m) (i.e. a 26' dwelling on a 38' lot) for all amenity lots, providing that both the front porch and the rear deck are extended out on the entry side of the home to fill the lot to the minimum side yard (see Example C). For examples on Single Family Detached lots, please see Appendix C.

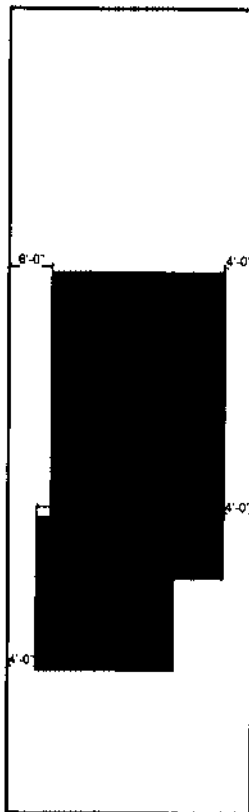

EXAMPLE A

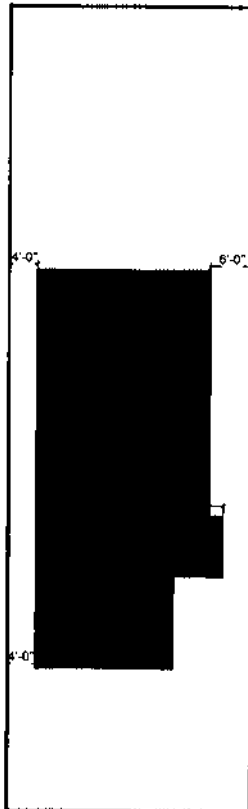

EXAMPLE B

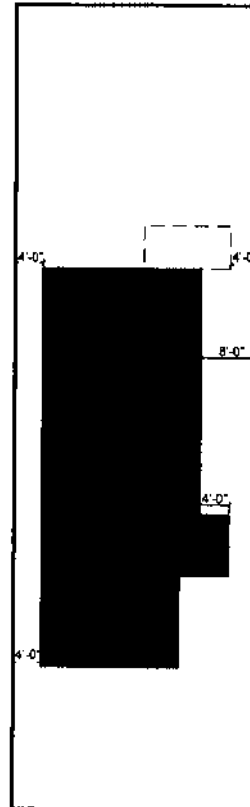

EXAMPLE C





### 3.4 Lot Grading

Lot grading must be in compliance with the Town of Cochrane Surface Drainage Bylaw 13/2005. Builders should give due consideration to building grades when determining house types in order to assure that an appropriate house is located on each homesite. Lot slopes should be absorbed within the building massing as much as possible.

- Builders must pay close attention to drainage patterns created on the homesites in order to ensure surface water is channelled away from the house on all sides and into adjacent drainage swales and storm water systems.
- Builders are to ensure that all of the corner and intermediate elevations, as established by the development engineer, be maintained exactly as specified.
- Maximum permitted front, rear or side yard slope is 3:1, builders are encouraged to stay within 5% - 25% slope.
- The lot grades create a drainage pattern, as indicated on the "grade plan", and must be maintained.
- Site drainage must be established prior to commencing construction and maintained by the builder throughout the construction period.
- Individual lot grading (including drainage swales and retaining walls) must be completed within individual home site property lines.





## 4. ARCHITECTURAL DESIGN

### 4.1 Proposed Housing Product

Single Family Laned and Front Drive Semi-Estate homes will be offered in Sunset Ridge Phase 21A. The proposed housing product will be bungalow and two storey homes with front porch in Craftsman, Arts and Crafts or Prairie styled designs. All laned homes are considered a starter product and are expected to strike a balance on the quality of architectural detailing and price point within the product segment.

### 4.2 Repetition

Single family home designs with near identical house elevations and colours may not be repeated more often than every fourth (4th) home on the same side of the street and every third (3rd) home on the opposite side of the street.

To be different means that there is a significant change in features such as roof type, size and location of windows and doors, colours and finish materials. A change of materials alone and reversing the plan is not sufficient.

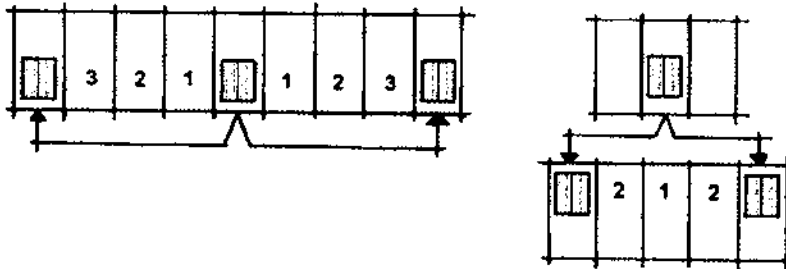

### 4.3 Architectural Theme & Style

Craftsman, Arts and Crafts, and Prairie will be the preferred architectural style for Sunset Ridge Phase 21A; however other styles may be approved at the discretion of the Architectural Coordinator. Please refer to section 4.5 "Architectural Style" for a detailed description of these styles.

**Note:** The Developer and the Architectural Coordinator reserve the right to accept home designs which, in the opinion of the Architectural Coordinator, meet the intent of Architectural Guidelines set out herein in all respects.



### 4.3.1 Craftsman / Arts and Crafts

Craftsman and Arts and Crafts will be the preferred architectural styles for Phase 21A of Sunset Ridge. Other architectural styles may be permitted at the discretion of the Architectural Coordinator.

Craftsman homes generally have moderate pitched roofs, while Arts and Crafts are steeper in pitch. Both styles may include second storey dormers, covered front verandas, decorative beams or braces and the use of traditional building materials in deep rich colours. It is encouraged that the upper floor living space of two storey homes be built into the roof massing.

Siding and trim colours should be inspired by natural surroundings and should complement the natural materials used on the home.

Masonry is essential for these styles and should only be used on the base to ground the home to add a presence of stability. Masonry heights may vary but the thickness should always be much greater than the pier. Elements like brackets, blocks, false trusses and exposed rafter tails are encouraged to give the presence of craftsmanship.

#### Craftsman Elements:

- Moderate roof pitch
- Use of stone or brick and natural materials
- A high level of architectural detailing on doors and windows
- Wood blocks and brackets

#### Arts and Crafts Elements:

- Steeper roof pitch
- Alternate materials used on upper floor
- Board and batten detailing in contrasting colours

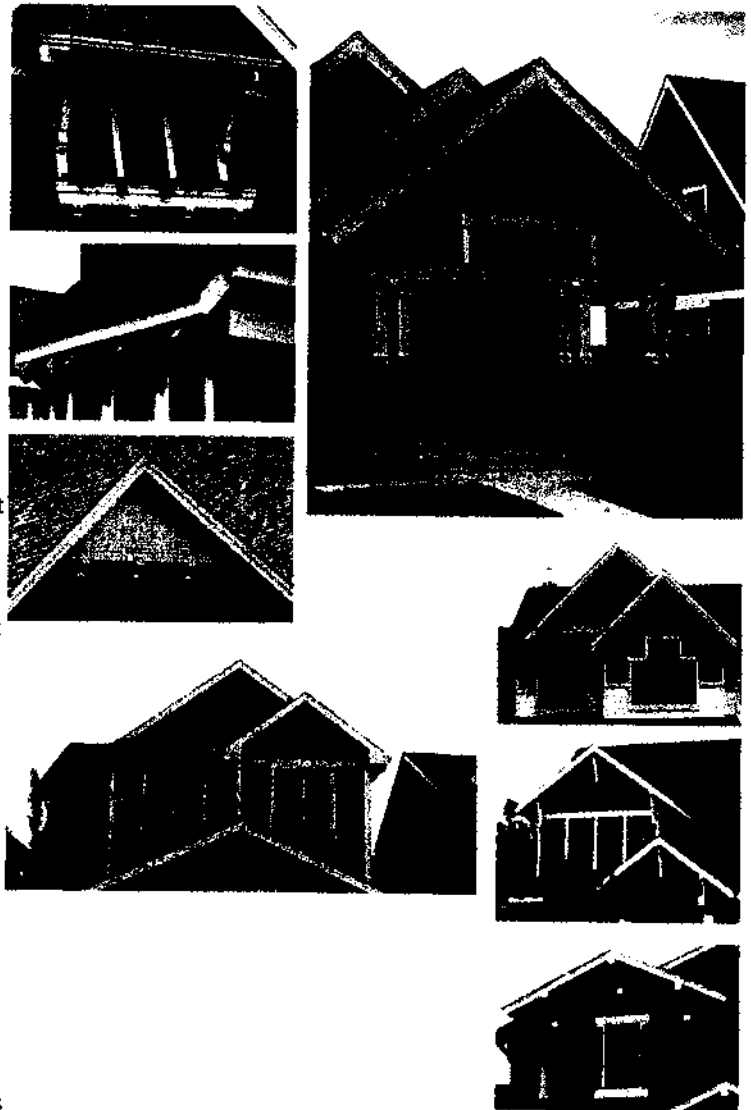



### 4.3.2 Prairie

Prairie dwellings are characterized by a low, grounded built-form, and shallow pitched roofs with wide overhanging eaves. The minimum required roof pitch on Prairie homes will be 4:12 with 24" minimum overhangs. Eaves are permitted to project a maximum of 600 mm into the side yard setback.

Wood of various types is the most common exterior surface combined with the use of brick or stone. Board and batten, horizontal siding and paneling are all common wall surfaces. Veranda and porch elements are major elements in the composition. Breezeways are also a common element, used to connect different portions of the building and provide weather protection.

Windows are typically casement type with substantial wood trim, and grouped together in bands to enhance the ground-oriented built form. Colours vary from the lighter shades of stained or painted wood siding through weathered grays to rich earth tones.

Chimney are generally wider on these homes and finished in brick or stone. Horizontal lines through the home are emphasized through the use of stone and battens.

#### Typical Design Elements:

- Low-pitched hip roof (a min. slope of 4:12)
- Wide overhanging eaves (a min. of 24")
- Horizontal and flat lines
- Low proportions
- Broad flat chimney
- Grouped casement windows
- Extensive wood trim
- Veranda and porch elements
- Massive square porch supports

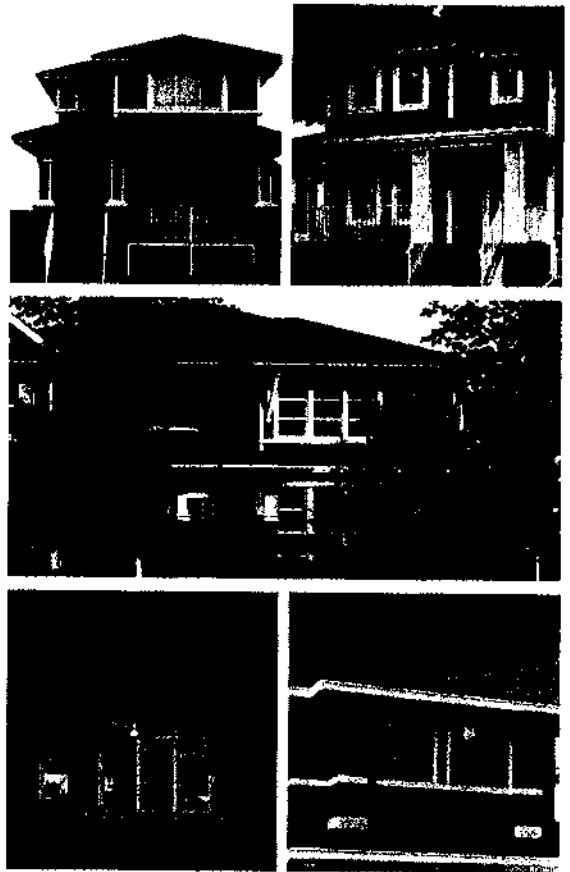



## 4.4 Building Form and Massing

### Front Attached Garages

- A minimum of a double front attached garage will be required on these lots. The attached garage should reflect and complement the overall massing and proportion of the home and not dominate the streetscape. Triple car garages may be approved at the discretion of the architectural coordinator and must have at least one bay of the triple garage recessed or extended out 12" from the others.
- If the third bay of the garage is fully offset from the main body of the home, special attention must be paid to the roof design and massing in order to integrate the third garage bay into the overall appearance of the home. Attached triple car garages must be a natural extension of the design, massing and materials of the main dwelling.
- In order to reduce the visual impact of front drive garages, close attention will be paid to the architectural design of the front elevation and the design of the front entryways. One method in achieving this is bringing the front entryway of the home as far forward as possible, without adversely affecting the interior layout of the home. Deeper porches and roof lines that extend past the steps are highly encouraged to provide a better sense of enclosure over the entry.
- The garage location is noted on the building grade plan and the subdivision marketing plan. **Builders are required to use the garage location as shown unless otherwise approved by the developer.**
- Extra wide double car garages shall not be permitted unless otherwise approved at the discretion of the architectural coordinator.

Garages will generally be paired with the neighbouring homes unless noted otherwise on the subdivision marketing plan.

### Single Family Laned Homes

Entrances of Single Family Laned home should be emphasized through roof articulation, detailed front porches, and other treatments. Overall massing on laned single family homes shall provide a resemblance to a larger single family home. All homes will have the option of a rear detached garage, concrete parking pad or a gravel parking pad.

Rear detached garages will be permitted on Laned Single Family lots only. On lots where garages require a party wall, the garages must be built at the same time as the homes. Lots that have adequate width to accommodate a free-standing garage, the garage can be built at a later date. High exposure corner lots require the garage to be built with the home and be enhanced on exposed elevations. This includes lots 28 and 29, Block 42.

Concrete parking pads are highly encouraged, but gravel parking pads must be provided at a minimum. Gravel parking pads must be boxed in with wood.



#### 4.4.1 Roof Design and Pitch

The roof design is important to achieving the desired look of the Architectural styles. A minimum of 6/12 roof pitch will be required on all Craftsman/Arts and Crafts homes and a minimum of 4/12 roof pitch for all Prairie style homes. Roof vents and plumbing stacks must be located away from the street view of the house where possible.

- Overhangs on all roof configurations shall be a minimum of 18" on Craftsman/Arts and Crafts and 24" for Prairie.

#### 4.4.2 Two Storey Front Massing

Homes that incorporate second floor living space being built flush with the front face of the garage will be permitted subject to a combination of cantilevers, roof lines, and box outs being used to break up the flat massing. Builders will be asked to extend parts of the facade past the front of the garage. The front porch massing on these homes must also be at a maximum distance of 6' from the front of the garage. Homes with living space being built flush with the front of the garage may not be repeated more often than every third home on the same side and opposite side of the street.

All elevations subject to this section will require pre-approval to ensure enhanced architectural detailing is being provided.

#### 4.4.3 Corner Lots

Corner lots that side onto a street or open space will require substantial additional treatment. The side elevation shall be well articulated with various architectural elements appropriate for the overall design of the house. Battens will be required on openings. Other elements may include box outs, rooflines or verandas that wrap around the exposed building face shall be the preferred treatment, chimneys and fully detailed windows, and shadow bands.

Furthermore, a wraparound porch or extended width porch is required, unless otherwise approved at the discretion of the architectural coordinator. When provided, a wraparound porch should return at least 3' from the foundation corner.

Lots that require this treatment:

Block 23 - Lot 102, Block 41 - Lots 18, and Block 42 - Lots 28 and 29.

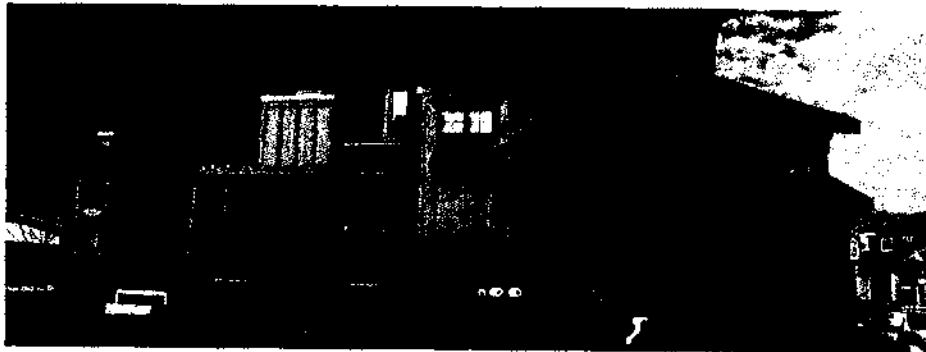



#### 4.4.4 Front Porches

All homes shall incorporate a front porch into their designs to integrate with the streetscape and must be maximized in size and length to provide a more pedestrian friendly environment. To ensure the functionality and correct massing a minimum depth of 6' will be required for all porches. The width of the porch is suggested to be the full width of the home. Narrower porches may be approved.

If a design is submitted that does not meet these requirements but has adequate detail and massing it may be accepted at the discretion of the Architectural Coordinator.

The underside of the porch is to be screened in an appropriate and complementary material so that the underside of the porch is not visible. Lattice will not be permitted. Stone, brick, panelling, board and batten or shake are permitted as skirting materials. The front steps and landing are encouraged to be constructed of concrete, but wood or other alternate materials will be permitted.





#### 4.4.5 Rear Elevations

All rear elevations will require some additional detailing that will include trim around openings as per Section 5.4. Large exposed flat walls will not be permitted. Designers will be required to articulate rear elevations to breakup the vertical massing. This can be achieved through the use of decks, rooflines and by stepping back the upper floor where warranted.

Rear elevations on corner lots will require the same level of detailing as the front elevation.

#### 4.4.6 Exterior Decks and Patios

Railings will be required on front steps on any homes with more than three steps. Front porches, landings and rear decks shall have railings in a style to match the architectural theme of the home. Supporting columns for decks and porches are to be architecturally detailed and must have a minimum dimension of 300mm square (12" x 12"). The cap and base of the columns must be detailed and built out. The main beam and rim joist must be clad in smartboard or an approved equivalent. The same requirements apply to stair stringers in instances where they are exposed.

All corner lots, will require decks with (12" x 12") built out columns or skirting to be shown on the plans and built at the time of construction of the home. Deck and column requirements on remaining standard, non-exposed lots are at the builder's discretion.

#### 4.4.7 Chimneys

Chimneys must be finished to match the exterior wall material. Stone or brick finishes on chimney chases are highly recommended. On corner lots, where chimneys are provided, builders are required to bring the chimneys down to grade and are encouraged to be constructed full height chimneys that would extend past the upper floor level.

#### 4.4.8 Retaining Walls

Where retaining walls are required it is recommended that they are constructed using natural materials, i.e., sandstone boulders, rundle rock or river rock (mortar). Retaining walls not constructed from natural materials should be constructed with a visually aesthetic material, i.e., decorative concrete, or concrete with a stone or brick facing. Concrete wing walls will be acceptable when not visible from the street and require approval from the Architectural Coordinator.

Retaining walls will be limited to a height of 4 feet (1.22 metres). All retaining structures must be within property lines. Any retaining wall exceeding 1.00 metre in height MUST be approved by a professional engineer and may require a development permit.

In no instance shall a retaining wall be introduced to a lot to artificially revise the grades approved on the building grade plan unless otherwise approved by the developer.





#### 4.4.9 Columns

All columns must be boxed out in crezone or smartboard detailing (siding not permitted on columns) and be a minimum size of 12"x12", they should show structural integrity and have a rich level of detailing to reflect the traditional style of the home. Porch columns should return to grade wherever possible.



#### 4.4.10 Gable Treatment

All gables on front and side elevations facing a street, and rear elevations backing onto open space will require additional decorative detailing and an alternate material. Siding on its own will not be allowable on these gables. A horizontal batten separating the main wall and the gable is suggested, as shown below.

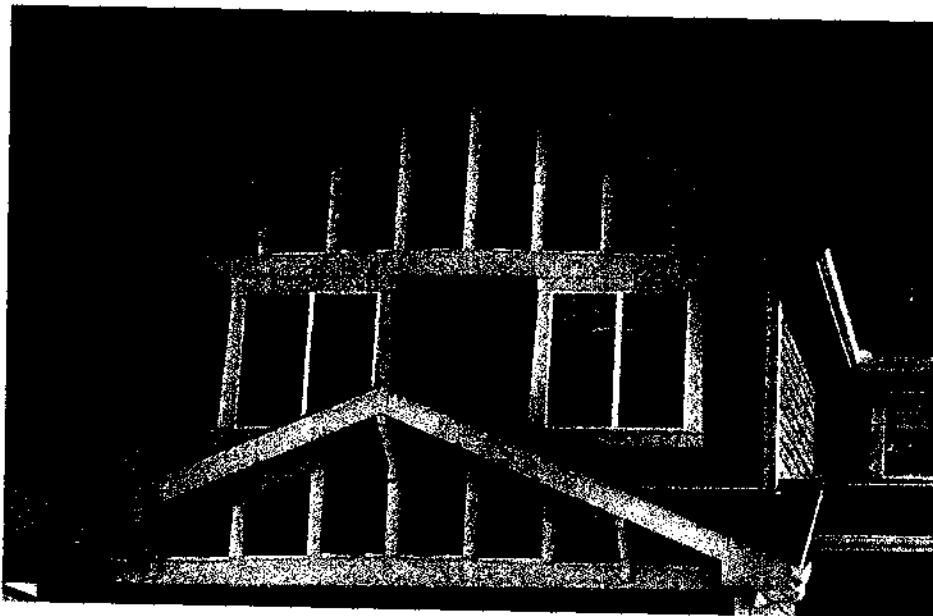



## 5. BUILDING MATERIALS AND COLOURS

### 5.1 Primary Wall Materials

#### VINYL SIDING

- Vinyl siding with a Beveled/Traditional lap profile in a premium dark colour will be the minimum requirement for laned homes. Smooth finish stucco and composite siding will also be approved as an upgrade. **Dutch Lap vinyl siding will not be permitted.**
- Secondary wall materials may include smooth composite panels, cedar shakes and composite shakes. Vinyl shakes may be approved at the discretion of the architectural coordinator on lots where vinyl siding is permitted. Vinyl shakes are to be in a straight cut profile. Other alternatives may be approved at the discretion of the Architectural Coordinator.

#### COMPOSITE SIDING

- Composite siding is the required primary wall material for all semi-estate lots.
- Full composite siding is highly recommended on standard lots, however vinyl siding will be permitted non-exposed elevations.

**Note that the garage return to the front entry is considered exposed on all homes and will require composite siding.**

- Vinyl siding must be a Beveled/Traditional lap profile in a premium dark colour. **Dutch Lap siding will not be permitted.** Colours must match where composite siding and vinyl siding are used on the same home.

Before submitting colours builders should review adjacent house colours to avoid repetition.





## 5.2 Exterior Colours

Approved primary siding colours can be found in Appendix A. Alternate colours not listed in Appendix A may be approved at the discretion of the Architectural Coordinator.

Siding and stucco colours must be a dark, rich hue for the primary wall material. Pastel and light shades of colour will not be permitted.

It is the intent in Sunset Ridge to highlight the streetscape with interesting vibrant colour schemes. To achieve this, a secondary material will be required on the front, exposed side, and rear elevation of every home. Secondary colours must offer a striking contrast to the main body of the home, not a lighter or darker shade of the same colour.

Painted trims must be completed in a contrasting colour to the primary and secondary wall materials that provides interest to the home's detailing.

## 5.3 Masonry

The use of masonry will be encouraged on all homes in Phase 21A and should be used in portions reflecting structural integrity. There will be no minimum amount of stone or brick required but the placement of the material must ground the home and act as a structural element. All stone or brick must wrap at least 3' around the garage return to the porch. A 2' return will otherwise be permitted on any non-exposed side elevations. In cases where the distance between the face of garage and the porch exceeds 10', masonry or alternate material on the front of the garage will be required to return along the length of the garage wall to the face of the porch or pillars. The end of the return will need to be finished with trim that sits proud. Only natural stone, manufactured stone and brick will be permitted as masonry materials.

Designs with no masonry may be accepted at the discretion of the Architectural Coordinator. These homes will require extensive detailing and trim elements to compensate for the lack of masonry detailing.





## 5.4 Trim, Fascia and Soffit

Modern trim materials used in a traditional manner will assist the homes in Sunset Ridge Phase 21A to appear traditional and timeless. Designers are asked to put a great deal of efforts into the trim detailing.

- Trim around windows and door openings will be required on the front and rear elevations of all homes, including the side elevations of corner lots.
- Trim detailing around all openings is highly encouraged for all non-exposed rear elevations. However, if the home is offset at least three lots from a street corner, a relaxation to the trim requirements around opening on the main level will be permitted. Full trim detailing on all openings will be required if the home is within three lots of the street corner.
- Trim material shall be Smartboard, PVC, or equivalent. Smooth finish acrylic stucco battens will also be acceptable.
- 4" minimum composite corner boards will be required on the front elevation and will also be required on elevations that are visible from open spaces or the street. Corner boards are suggested when using stucco as a wall finish, but it is not required. **Corner boards are to match the trim colour used on the home.**
- Shadow boards or cornices, if incorporated in the design, shall be used in all open gable ends where the wall meets the soffit on all front and rear elevations.
- The fascia on open gables on the front and other highly visible elevations is to be constructed with a composite material. All other fascia may be aluminum. All fascia must be a minimum of 8 inches in height.
- Rainware should be limited on exposed elevations. Downspouts should take place on side and rear elevations of homes only. Rainware should match colour of soffit and fascia used on home.

## 5.5 Windows

Window layout is key to achieving a chosen design style. Windows should be positioned in good proposition and relationship to one another on an elevation. If fenestration is not setup properly, walls can look scattered and unorganized.

- Casement, double-hung, and single-hung are appropriate window types and may be incorporated with non functional windows to create more elaborate window designs. Sliding windows in bedrooms will be acceptable.
- Skylights, if used, should be black in colour to match the roofing and should have a flat profile. Skylights should be incorporated on rear elevations and should not be visible from the street.



## 5.6 Roofing

The roof material for all homes is to be premium architectural asphalt shingles such as IKO Cambridge 30 (or equivalent), recycled rubber composite shingles, or concrete tile in the slate profile with a dark colour. Other equivalents or upgrades may be approved at the Architectural Coordinator's discretion. No wood shakes will be allowed. All roof stacks must be enclosed and/or finished to compliment the roof colour and exterior finish detail.

**Dual Black or an equivalent will be the approved roofing colour when asphalt shingles are used.**

Rainwater leaders and soffits shall match or compliment the approved trim colour.

## 5.7 Roof Hardware

All roof hardware (vents, stacks, flashing, etc.) must be prefinished or painted to match the colour of the roofing material. **Unfinished galvanized flashing will not be permitted.**

## 5.8 Front Doors

- Front entry doors are to compliment the architectural style of the home.
- Entry doors are to have glazing and/or sidelights and/or transom windows.
- Single or double front entry doors are allowed. Double front entry doors will be approved at the discretion of the Design Coordinator.
- Sliding patio doors shall not be located on front elevations.

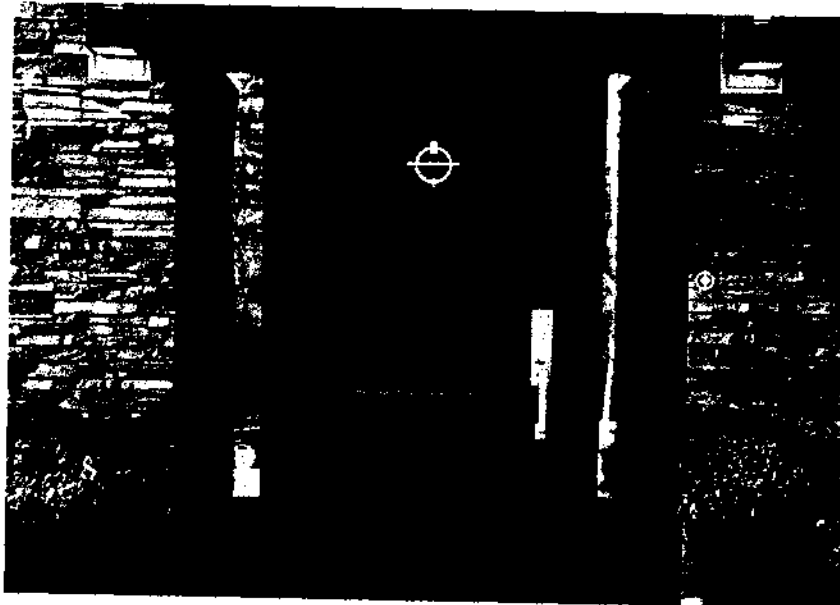



## 5.9 Garage Doors

- The minimum specification for garage doors will be the Gallery Collection from Clopay doors or equivalent.
- Are not to exceed 8 feet in height and 20 feet in width unless approved by the Architectural Coordinator.
- White garage doors will not be approved unless the trim colour on the home is approved as white.
- Additional space above the garage door to eaves line (more than 24 inches) will have to be justified and treated with an architectural feature.
- To further enhance the front facade of the homes, it is recommended that all garage doors include glazing panels in a design that suits the home's exterior and the garage door style. **Glazing panels will be required on all doors on amenity lots and those that exceed 7' in height.** They will also be required on all homes that do not include masonry.



Garage Doors must be painted to match the main or secondary wall colour and trims are to be painted to match the main trim colour of the home. Doors that are painted a wood colour may be approved at the discretion of the Architectural Coordinator.

## 5.10 Railings

Acceptable railing materials include:

- Wrought iron/aluminum
- Glass panel (rear only)
- Wood railing in a decorative design may be approved on front verandas only and must compliment the design.



## 5.11 Driveways and Sidewalks

Exposed aggregate finish is highly encouraged for all homes with front attached garages. However, broom finished concrete will also be permitted in Phase 21A.

- All driveways are to have a joint 2.4 metres from the back of curb. This will reduce damage to driveways as a result of water valve maintenance.
- The width of all front driveways shall not exceed the width of the garage face. In no instance shall front yard landscaping be removed and replaced with hard surface such as poured concrete, paving stones, asphalt, concrete blocks, decorative concrete, etc. The approved plot plan showing the extent and dimension of the front driveway shall remain valid and in force in perpetuity unless otherwise authorized by the Developer.
- A 20x20 enclosed gravel parking pad at the rear of the lot will be required as a minimum. Concrete parking pads are encouraged, and may be built to accommodate future garage construction.
- Sidewalks must be a minimum of 3' in width.
- Sidewalks are to be broom finished concrete, as a minimum.

## 5.12 Front Steps

- Decorative pre-cast concrete porches and steps are encouraged, but may be smooth finish at minimum. Exposed aggregate steps will be required when aggregate walkways and driveways are installed. However, exposed aggregate steps which have a smooth concrete tread will also be approved.

## 5.13 Parging

A maximum of 16" parging will be permitted on side and rear elevations measured from final grade to the underside of the wall finishing material. On sloping lots, siding will have to be dropped accordingly and applied to the foundation walls of the home. A maximum of 8" of parging will be permitted on front and exposed elevations.

## 5.14 Lighting

Pot lights or light fixtures with a traditional look are encouraged for the front entry. All light fixtures shall complement the architectural style of the home. Flood lights will not be permitted. All light fixtures shall be fully shielded and oriented to direct all light below the horizon.

Rear exterior lighting with photocell light sensor will be required on all garages backing onto a lane.



## 6. ADDITIONAL REQUIREMENTS

Nothing herein contained shall be construed or implied as imposing on the Developer, its agents or employees, any liability in the event of non-compliance with or non-fulfillment of any of the terms, restrictions and benefits set forth herein and no liability or responsibility whatsoever shall be incurred by the Developer, its agents or employees, in the performance or non-performance of their rights and obligations herein.

### 6.1 Recreation and Commercial Vehicles

Recreational vehicles and commercial vehicles shall not be parked in front or exposed corner of a home for any reason other than loading and unloading. When RV's are parked on site they must be parked on the side of the home and be properly screened from the street. Wood screen fence is an acceptable screening mechanism, but may only be used alongside the house. RV parking will not be permitted within any yard exposed to the street.

### 6.2 Satellite Dishes

Satellite dishes are allowed provided the dish size does not exceed twenty-four (24") inches in diameter and the location of the dish is concealed to minimize visual impact.

### 6.3 Solar Panels

Solar panels are permitted, and their use in Sunset Ridge Phase 21A is encouraged by the developer. Please contact the developer for information on builder incentives or rebates for solar panel use within the development. All solar panel systems are to be submitted to the Architectural Coordinator for review. Solar panels are to be installed on roof surfaces only, and the locations of all proposed solar panels are required to be shown on the house elevations. Panels are to be black to match the roofing color, and must be flat in profile. Other types of solar power systems may be approved, but will be subject to the review and approval by the Architectural Coordinator.





## 7. LANDSCAPING

### 7.1 Fencing

All fencing shall conform to the Cochrane Land Use Bylaw.

Fencing along the rear and side property lines is optional and must be constructed in accordance with the fence shown in Appendix B.

See Appendix B for fencing specifications.

### 7.2 Front Yard Landscaping

The front yard landscaping must be completed within four months of the completion of the home but is subject to seasonal constraints.

### 7.3 Fire Pits and Outdoor Fireplaces

Fire pits and outdoor fireplaces will be permitted in the rear yard only and are to follow the Town of Cochrane Bylaws.



## 8. APPROVAL PROCESS

### 8.1 Preliminary Review

To achieve the desired traditional look in Sunset Ridge, designers are encouraged to create preliminary renderings or sketches of home plans and elevations to the Architectural Coordinator for preliminary review to ensure that they are on the right track.

### 8.2 Formal Application Submission

Builders will have to submit their plans to the Architectural Coordinator for architectural review and confirmation of compliance with these Architectural Guidelines before they will be permitted to apply to the Town of Cochrane for a building permit. The design coordinator will require the following information submitted via [www.archcontrol.com](http://www.archcontrol.com):

- Exterior colours including trim, siding and stone.
- Plot Plan (1:200 scale) showing the following:
  - Lot size
  - Building envelope
  - Setbacks
  - Lot coverage
  - Easement and utility rights of way
  - Property and house corner grades
- Construction Drawings (1/4"=1'; 3/16"=1')

**Builders must ensure all customer names are removed from their drawings before Architectural Submission.**

### 8.3 Final Inspection

At the completion of the exterior of the home, the builder is to request in writing a final inspection from the Architectural Coordinator to ensure that the home is in compliance with the design guidelines and the approved home plans.

### 8.4 Schedule of Applicable Fees

The fee for first Architectural Approval and Pre Approval will be paid by the Developer.

Any changes after the initial submission will be billed to the builder at the following unit costs:

- Change Requests.....\$ 75.00 /change
- Secondary Architectural Approval.....\$ 400.00
- Fee for consultation:
  - Senior AT.....\$ 170.00
  - Intermediate AT.....\$ 85.00





## 9. CONSTRUCTION REGULATIONS

### 9.1 Material and Equipment Storage

- Builders will be allowed to store their materials and equipment on site during construction but may not store on any other home sites.
- Items stored will have to be stored in an organized and covered manor to ensure site cleanliness.
- Builders must ensure that they do not trespass or disturb any other properties.
- Cleaning of paint, solvents, stains, etc will not be permitted on site.
- Concrete trucks may not clean chutes anywhere on site.
- Storage will not be permitted on any road or sidewalk.

### 9.2 Use of Site

- Construction debris and waste must be contained on site each day and removed at the end of the project.
- Debris may not be burned, dumped, or buried anywhere on site at any time.
- Site damage (curbs, site furniture, sidewalks, roadways, vegetation) will be the charged to the builder.
- Should a site not be maintained as these guidelines document, the developer reserves the right to rectify any deficiencies at the cost of the builder.

### 9.3 Vehicles and Parking

Utility trailers, etc. may be parked on site for the time of construction only, at the risk of the builder.

### 9.4 Other Notes

- Vegetation material, top soil, or similar materials may not be dumped on site at any time.
- Changing oil on any equipment or vehicles is not permitted on site.
- Alcohol and drugs are prohibited at all times on site.
- Erosion control will be the responsibility of the builder during construction.
- Builders are to ensure that sites are not access except via the provided entries.



## 10. DISCRETION

Notwithstanding anything else set out in these guidelines, the Developer, Melcor Developments Ltd. and the Architectural Coordinator may apply their respective judgements when considering and approving anything regulated or controlled by these guidelines. In so doing, the Developer and the Architectural Coordinator may provide waivers of or relaxations to any matter set out in these guidelines in their sole and absolute unfettered discretion.

The Developer and the Architectural Coordinator reserve the right to accept home designs which, in the opinion of the Architectural Coordinator, meet the Guidelines set out herein in all respects. Furthermore, the Developer and the Architectural Coordinator reserve the right to alter or make amendments to the Architectural Guidelines at any time without notice.

### 10.1 No Right to Enforce

Only the Developer may enforce the guidelines, no purchaser of a lot in Sunset Ridge Phase 21A may enforce these guidelines.

### 10.2 Right to Amend

The Architectural Committee may from time to time amend these guidelines as it sees fit in its sole and absolute unfettered discretion.

### 10.3 No Trespassing

No person shall infringe upon, excavate on, destroy, paint, fill in, cut, remove or tamper with any lot in Sunset Ridge that is not their own. If done so the Architectural Committee has full right to take legal action for relief of any violation.



## 11. CONTACTS

### Architectural Coordinator

IBI GROUP  
Suite 500  
611 Meredith Road NE  
Calgary, Alberta T2E 2W5  
Tel: 403.270.5600  
Fax: 403.270.5610

### Engineering Consultant

Pasquini & Associates Consulting Ltd.  
200 - 6025 12th Street SE  
Calgary, Alberta T2H 2K1  
Tel: 403.452.7677  
Fax: 403.452.7660

### Developer

Sunset Properties  
c/o Melcor Developments Ltd.  
210, 101-6 Street SW  
Calgary, Alberta T2P 5K7  
Tel: 403.270.1287  
Fax: 403.270.0538

### Architectural Committee

The Developer until otherwise established.





# APPENDIX A

## APPROVED SIDING COLOURS





## Approved Siding Colours

### Gentek - Sequoia

Venetian Red  
Dark Drift  
Saddle Brown  
Espresso  
Moonlit Moss  
Coastal Blue  
Midnight Surf  
Windswept smoke  
Iron Ore

### Royal - Colorscapes

Redwood  
Natural Cedar  
Shamrock  
Midnight Surf  
Granite  
Heritage Blue  
Ironstone  
Cocoa  
Wedgewood  
Bark  
Marine Blue  
Weathered Gray  
Storm  
Walnut  
Toasted Almond

### Mitten - Sentry (ACT)

Timber Bark  
Lighthouse Red  
Sapphire Blue  
Eggplant  
Annapolis Blue  
Richmond Red  
Coffee Bean  
Gunmetal Grey  
Regatta Blue  
Khaki Brown  
Rockaway Grey  
Muskoka Green  
Caribou Brown  
Chestnut Brown

### Kaycan - DaVinci

Pecan  
Mahogany  
Colonial Red  
Evergreen  
Cabot Brown  
Cabot Blue  
Cabot Red  
Castlemore  
Manor

### Kaycan - Verona

Boulder Gray  
Java Brown  
Tundra  
Urban Blue





# APPENDIX B

## FENCING





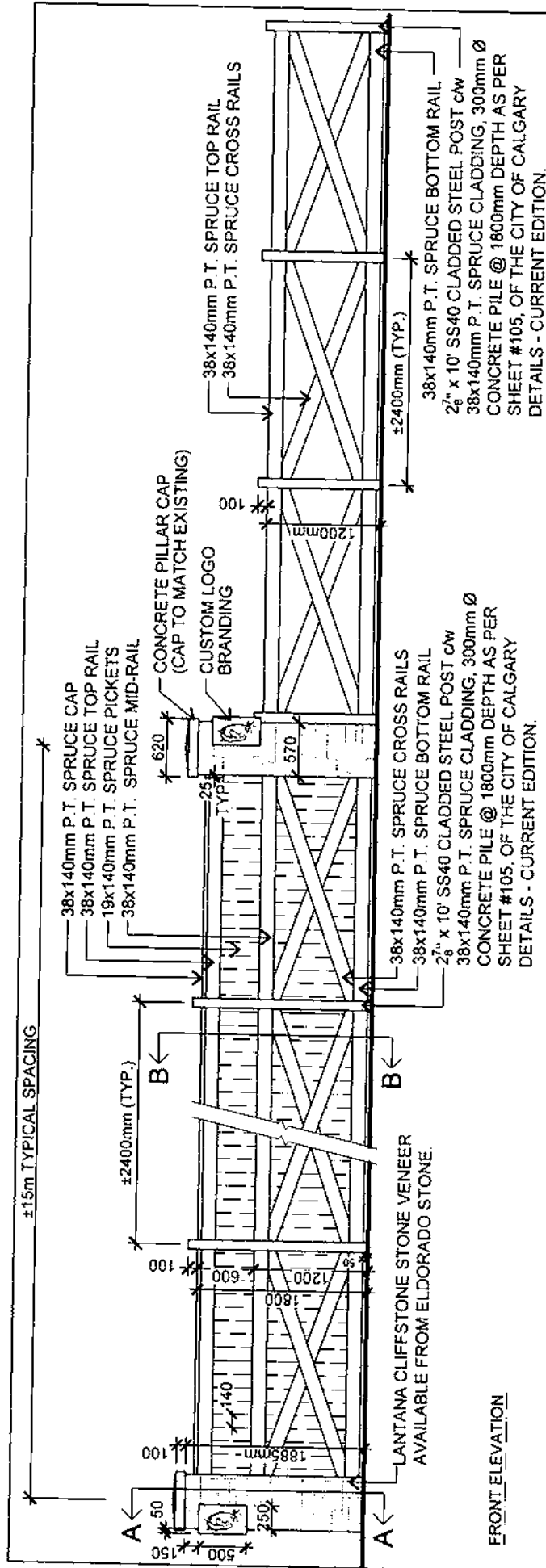

FRONT ELEVATION

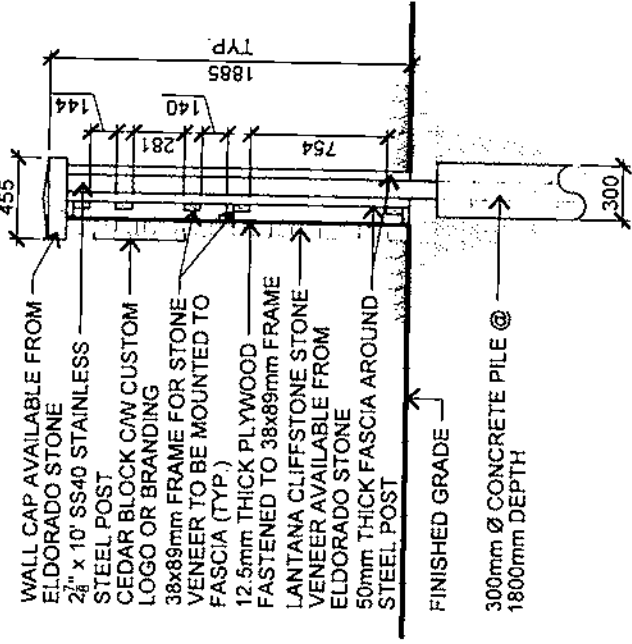

SECTION 'A' - BOXED OUT PILLAR

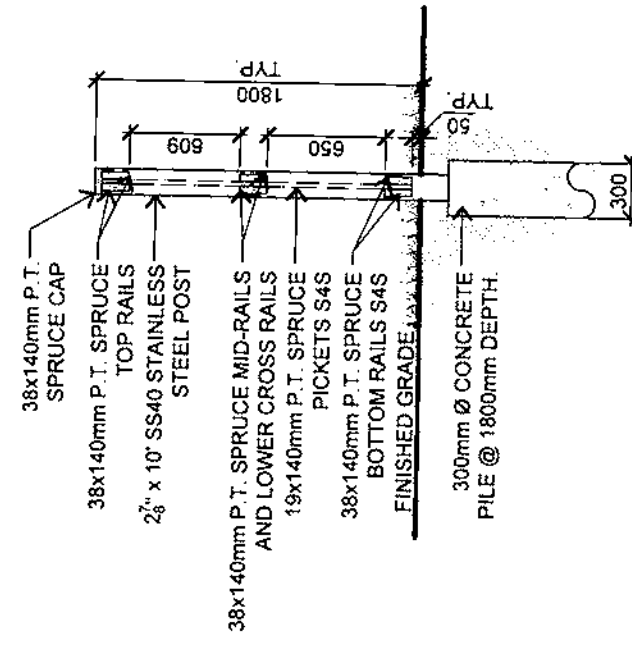

SECTION 'B' - WOOD FENCE (METAL POST)

PAINT SPECIFICATION:

NAME: 'SUNSET RIDGE'  
 'D' FLOYD BEIGE GREY - 1 GALLON FORMULA  
 EXTERIOR HYBRID SOLID STAIN FLAT

CCE*COLORANT	02	32	64	128
B1-BLACK	-	29	1	-
R2-MAROON	-	11	-	1
Y3-DEEP GOLD	2	24	1	1

AVAILABLE FROM SHERWIN-WILLIAMS.  
 SCAN 0027163-003.

- NOTES:  
 -ALL SPRUCE TO BE PRESSURE TREATED.  
 -ALL CONCRETE USED FOR PILE CONSTRUCTION IS TO BE LEFT 150mm BELOW FINISHED GRADE TO ALLOW FOR FINISH GRADE LANDSCAPING.

SUNSET RIDGE SIDE YARD FLANKAGE WOOD SCREEN FENCE  
 SCALE: 1:40

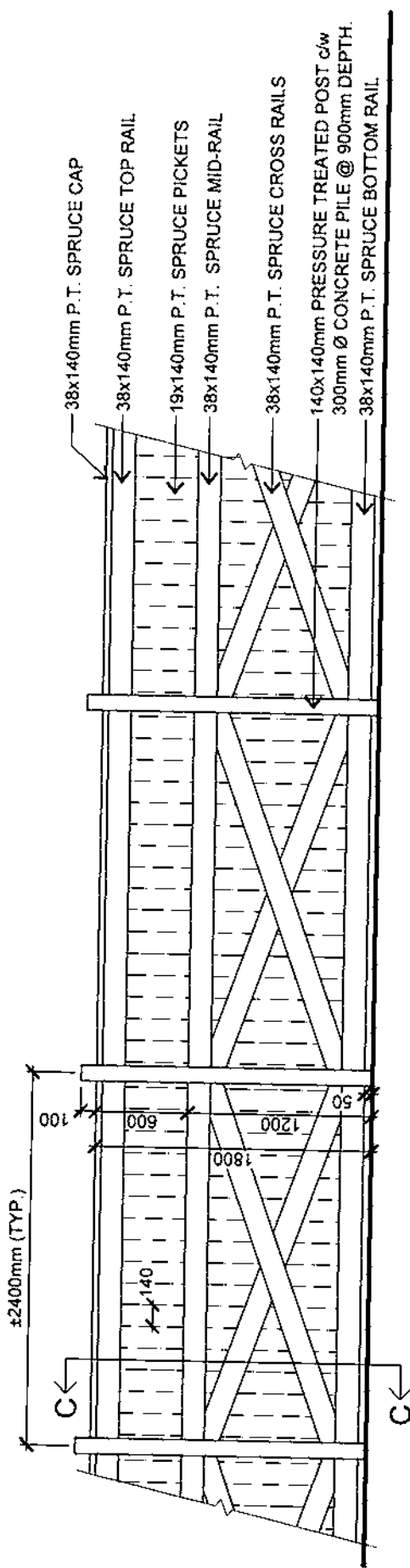

FRONT ELEVATION

PAINT SPECIFICATION:

NAME: 'SUNSET RIDGE'  
 'D FLOYD BEIGE GREY' - 1 GALLON FORMULA  
 EXTERIOR HYBRID SOLID STAIN FLAT

CCE*COLORANT	02	32	64	128
B1-BLACK	-	29	1	-
R2-MAROON	-	11	-	1
Y3-DEEP GOLD	2	24	1	1

AVAILABLE FROM SHERWIN-WILLIAMS.  
 SCAN 0027163-003.

NOTES:

- ALL SPRUCE TO BE PRESSURE TREATED.
- ALL CONCRETE USED FOR PILE CONSTRUCTION IS TO BE LEFT 150mm BELOW FINISHED GRADE TO ALLOW FOR FINISH GRADE LANDSCAPING.

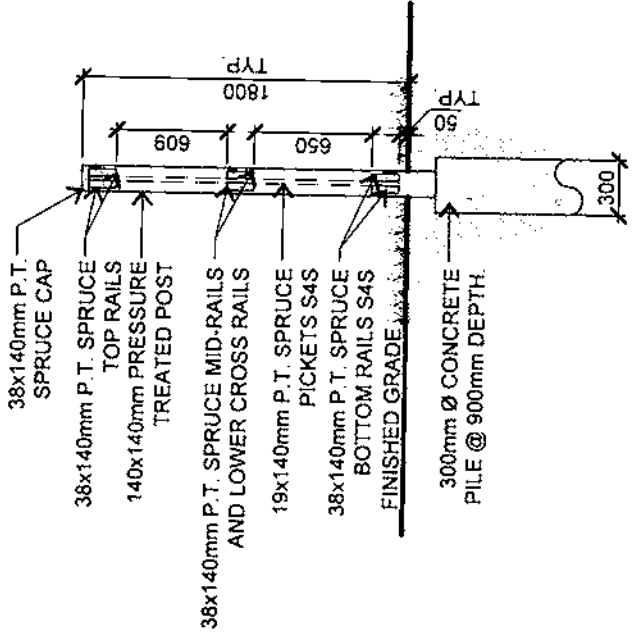

SECTION 'C' - WOOD FENCE (WOOD POST)

**SUNSET RIDGE WOOD SCREEN FENCE**  
 SCALE: 1 : 40

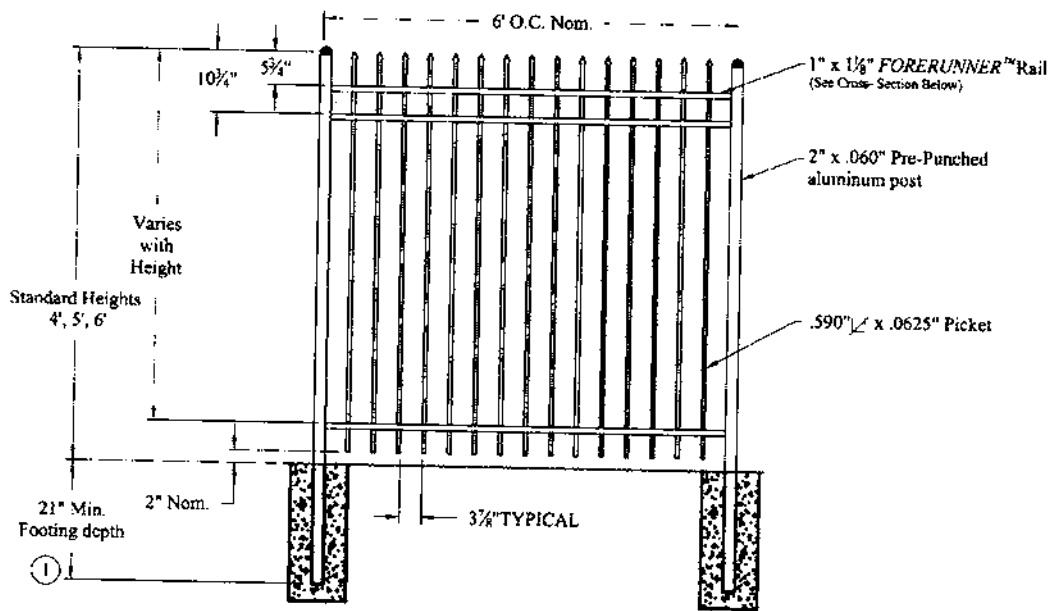

NOTES:  
 1. Post footing available in 21" or 33" depths.

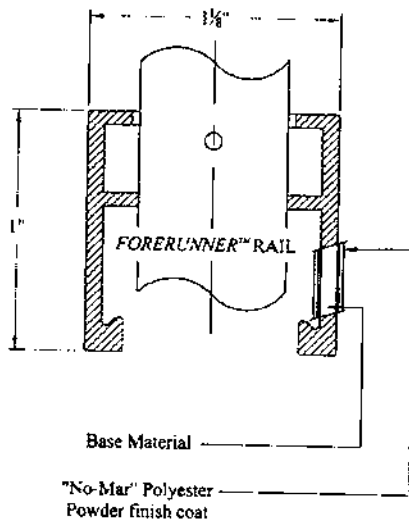

**INTERNAL RETAINING ROD**  
 Variable pitch connection system for ease of installation, high angle bias ability and elimination of unsightly external fasteners.

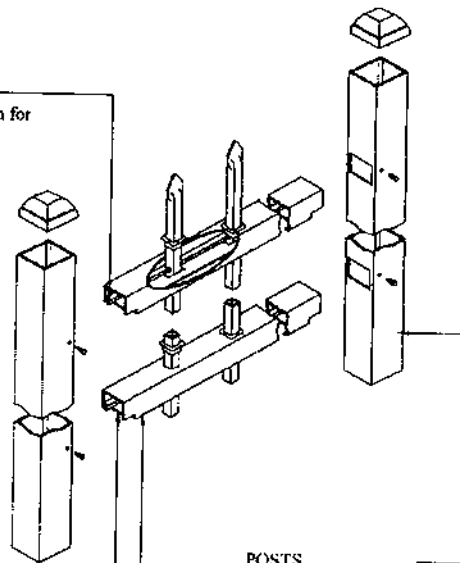

**INTERIOR GUIDE CHANNEL**  
 Channel forms lower limit of raceway for retaining rod and allows for high angle bias ability.

**FORERUNNER™ RAIL**  
 "U"-Channel specially formed high strength architectural shape.

**POSTS**  
 Special extruded aluminum shape with reinforced corners; pre-punched to eliminate brackets.

Values shown are nominal and not to be used for installation purposes. See product specification for installation requirements.

CISO

Title: <b>ECHELON CLASSIC 3-RAIL</b>		
DR: CI	SH. 1 of 1	SCALE: DO NOT SCALE
CK: ME	Date 6/25/10	REV: b



**AMERISTAR®**

1555 N. Mingo  
 Tulsa, OK 74116  
 1-888-333-3422  
 www.ameristarfence.com

**SUNSET RIDGE WROUGHT IRON FENCE 'A'**  
 SCALE: N.T.S.



# APPENDIX C

## SINGLE FAMILY LANED LOTS

## SIDE YARD ENHANCEMENTS



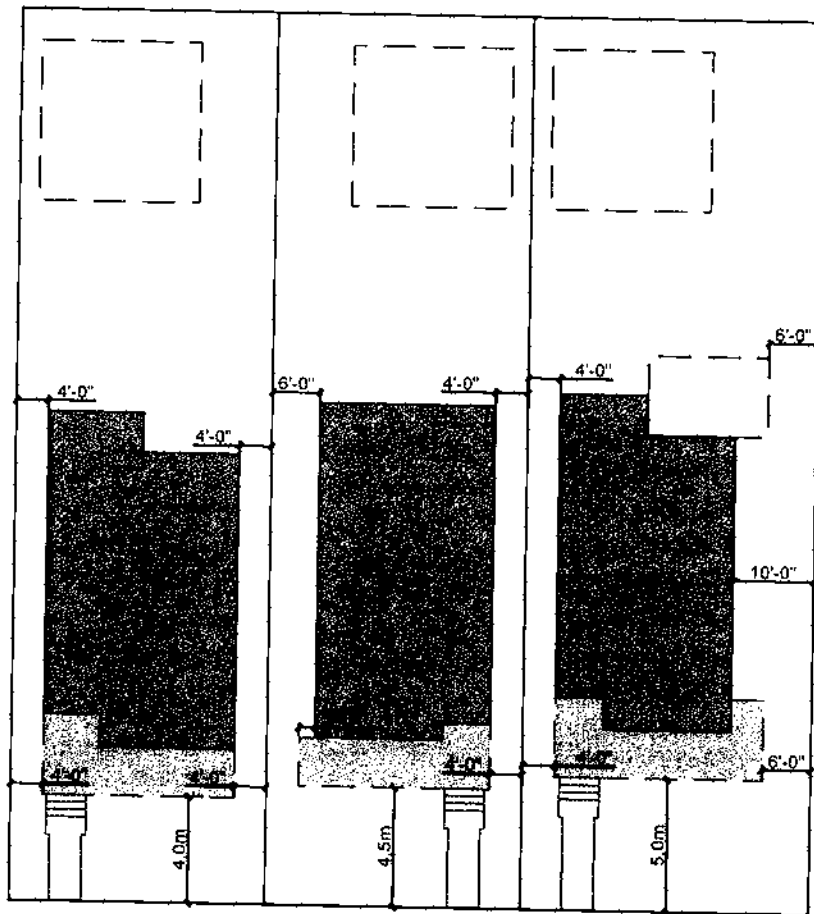

EXAMPLE A

EXAMPLE B

EXAMPLE C



# APPENDIX D

## FRONT YARD SETBACKS



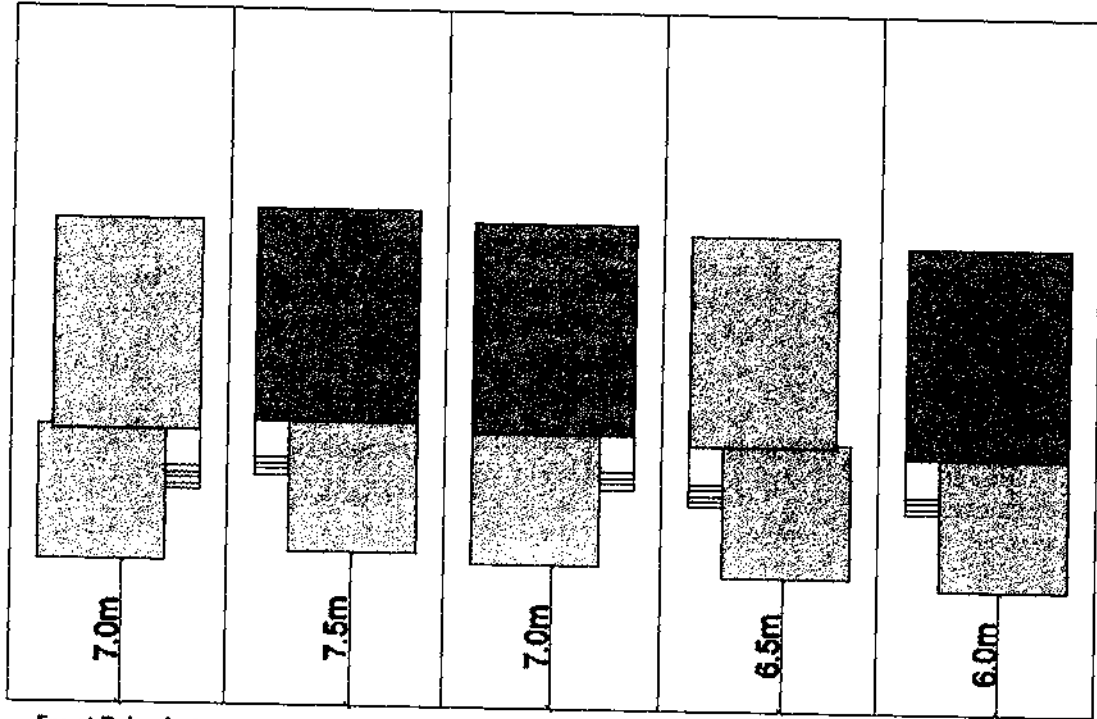

Front Drive Lots

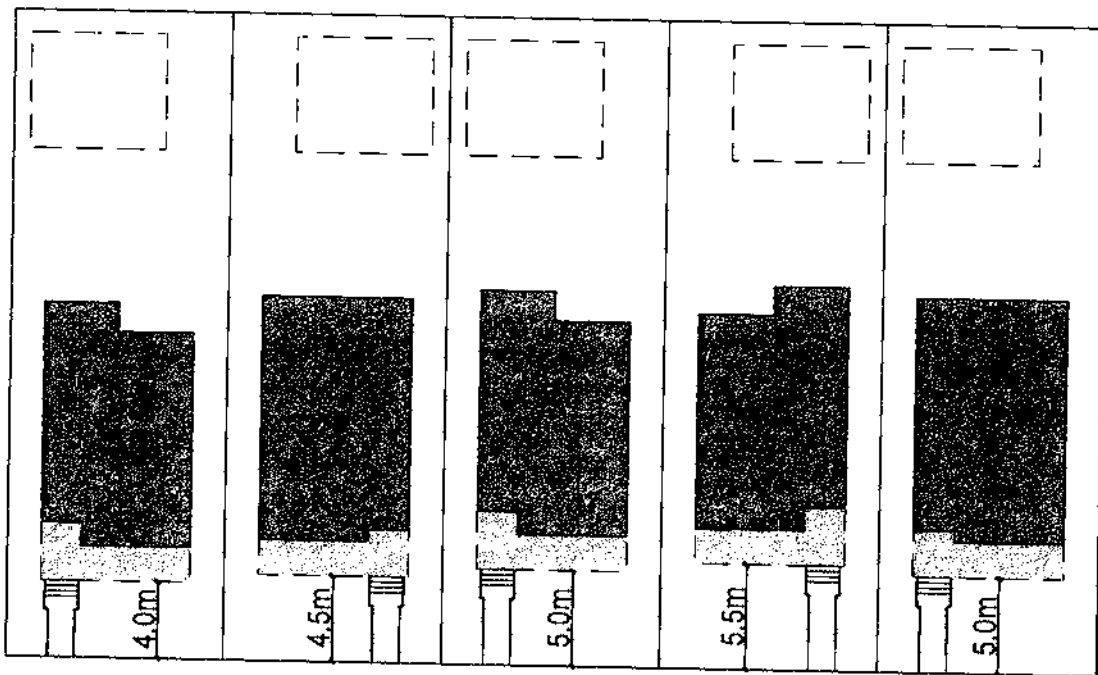

Laned Lots





# APPENDIX E

## LAND USE BYLAW

(Excerpted from the Town of Cochrane - Land Use Bylaw 01-2004 (Consolidated Version))





**SECTION 12.0.0 GENERAL REQUIREMENTS FOR RESIDENTIAL DISTRICTS**

**12.1.0 OBJECTS PROHIBITED OR RESTRICTED IN A RESIDENTIAL DISTRICT**

12.1.1

No person shall be allowed to keep or maintain on a lot:

- a) a commercial vehicle with a gross vehicle weight (GVW) rating in excess of 4,500 kg for longer than is reasonably necessary to load or unload the vehicle;
- b) any recreational unit in the front yard:
  - (i) except from May 1 to October 20 of any given year, when
    - A) such units may be parked or kept on the private front driveway;
    - B) a maximum of two (2) units will be allowed;
    - C) all portions of the unit are set back a minimum of 1 m from the back of the sidewalk or the curb, where there is no sidewalk; and
    - D) the unit(s) shall be parked parallel to the driveway;
- c) an industrial or construction vehicle except when such a vehicle is required pursuant to a development or building permit for that lot;
- d) any object or chattel that is unsightly or tends to affect adversely the amenities of the District. In accordance with the Act, the designated officer may order the owner to remedy unsightly or dangerous structures or property.

12.1.2

In addition to Section 12.1.1(b), a person may keep or park one (1) recreational unit in the rear or side yard of a lot year-round.

**12.2.0 GARDEN SUITES**

12.2.1

A garden suite is considered incidental and subordinate to the principal residence and shall:

- a) comply with all *Alberta Building Code* and other Provincial and Municipal regulations;
- b) be at-grade and not exceed 40% of the gross floor area of the principal residence to a maximum gross floor area of 80.00 m<sup>2</sup>;
- c) have a minimum gross floor area of 30.00 m<sup>2</sup>;
- d) have a maximum lot area coverage of 60%, when combined with all other buildings on the lot, notwithstanding Sections 13.4.2 and 14.4.2;
- e) not exceed one (1) storey in height;
- f) not exceed the maximum density prescribed for the subdivision in which it is located or a maximum of 10% of the number of existing lots in that subdivision, whichever is less;
- g) be placed to the rear of the principal building with a minimum separation distance of 1.83 m from any other accessory building and the principal building;

- h) notwithstanding provisions elsewhere in this Bylaw, have a minimum side yard setback of 1.20 m or, in the case of a corner lot, 3.00 m on the street-side;
- i) notwithstanding provisions elsewhere in this Bylaw, have a minimum rear yard setback of 1.20 m;
- j) comply with applicable architectural guidelines and be compatible with the neighbourhood;
- k) have full utility services through service connections from the principal residence.

12.2.2

The registered owner of the lot shall:

- a) be limited to one (1) garden suite or one (1) accessory suite;
- b) not subdivide title to the garden suite or accessory suite.

**12.3.0**

**ACCESSORY SUITES**

12.3.1

The registered owner of a lot shall be limited to one (1) accessory suite or one (1) garden suite, as outlined in Section 12.2.0.

12.3.2

An accessory suite shall:

- a) be accessory to the principal residence;
- b) comply with the *Alberta Building Code* and all Municipal and Provincial regulations;
- c) create minimal structural changes to the front exterior of the principal building, which shall appear as a single dwelling unit;
- d) not exceed 40% of the gross floor area of the principal dwelling;
- e) have a minimum gross floor area of 30.00 m<sup>2</sup>;
- f) have full utility services through service connections from the principal residence;
- g) not exceed the maximum density prescribed for the neighbourhood in which it is located or a maximum of 10% of the number of existing lots in that neighbourhood, whichever is less.

12.3.3

An accessory suite may be located in an accessory building.

12.3.4

Notwithstanding provisions elsewhere in this Bylaw, in the case of an accessory suite located above the ground floor of an accessory building, the following shall apply:

- a) The maximum height of the accessory building measured from the finished grade to eave line shall be 4.50 m;
- b) The roof pitch of the accessory building shall be a minimum of 4:12, match or complement the roof pitch of the principal residence, or shall be to the satisfaction of the Development Authority;
- c) The accessory suite shall have an entrance separate from the entrance to the accessory building, either from a common indoor landing or from the exterior of the structure;
- d) The accessory building shall have a minimum rear yard setback of 1.20 m and a minimum side yard setback of 1.20 m.

**12.4.0**

**REQUIREMENTS FOR MULTI-UNIT DWELLING DEVELOPMENTS**

12.4.1

All multi-unit dwelling developments shall provide amenity space for the residents to the satisfaction of the Development Authority. This amenity space may be private, communal, or a combination of both.

12.4.2

Where a multi-unit dwelling development is providing private outdoor amenity space for each dwelling unit, the amenity space shall be designed to provide visual privacy and be comprised of one (1) or both of the following:

- a) Patios and Courtyards: A minimum width or length of 2.40 m and a minimum area of 7.40 m<sup>2</sup> for each dwelling unit located at or below grade;
- b) Balconies and Porches: A minimum width or length of 1.50 m and a minimum area of 4.50 m<sup>2</sup> for each dwelling unit.

12.4.3

Communal amenity space shall be designed for the recreational use of all residents of the development. The area shall be indoor or outdoor space or a combination thereof, including but not limited to landscaped courtyards, public skating areas, swimming pools, fitness rooms, party rooms, games rooms, and children's play areas complete with equipment.

12.4.4

Landscaping of a lot for a proposed development shall be in accordance with Table 11.27.1.

12.4.5

The principal entry for every dwelling unit, except apartment units, must be separate and directly accessible to ground level.

12.4.6

The arrangement of the buildings in a dwelling group should strive to maximize privacy and is subject to the approval of the Development Authority.

**12.5.0**

**FRONT YARD SETBACKS**

12.5.1

In a new subdivision, the front yard setbacks of principal buildings shall be varied in order to maximize the visual amenity of the streets and neighbourhood.

12.5.2

The driveway accessing an attached or detached garage whose vehicle entry door faces a street shall have a minimum length of 6.00 m, measured from the property line to the closest point of the vehicle entry door.

**12.6.0**

**CONTROLLED APPEARANCE**

12.6.1

In examining a proposed use, due regard shall be given to the compatibility of the proposed use with existing uses on or adjacent to the site of the proposed use.

12.6.2

The façade of buildings shall be maintained to the standard shown on the site plan and elevation drawings approved by the Development Authority.

12.6.3

To ensure that manufactured homes in the R-1 and R-2 Districts are consistent with the buildings in the neighbourhood, these buildings shall be finished to the following standards:

- a) the height of the main floor above grade to be consistent with the height of the main floor of buildings in the immediate area;
- b) a minimum 4:12 roof pitch;

- c) exterior finishing materials used on the roof and exterior walls to be consistent with those used on the buildings in the immediate area;
- d) a minimum 0.40 m roof overhang or eaves;
- e) a maximum 3:1 length-to-width ratio;
- f) a minimum 6.70 m width;
- g) a permanent foundation;
- h) removal of the hitch and running gear.

#### **12.7.0**

##### **SHOW HOME PARADES (03/2008)**

Where there is a developer sponsored parade of show homes, dwelling units may be temporarily attached for the duration of the show home parade, but must be returned to the use intended by the bylaw prior to occupancy.

**SECTION 14.0.0 RESIDENTIAL SINGLE AND TWO-DWELLING DISTRICT (R-2) LAND USE RULES (16/2013)**

**14.1.0 PURPOSE AND INTENT**

14.1.1 The purpose and intent of this District is to provide for single-detached, semi-detached, duplex, and street oriented townhome residential development in existing neighbourhoods and new neighbourhoods that are designed to provide for integrated varying lot sizes, and to allow for a blend of different housing forms. These neighbourhoods may contain a limited number of accessory suites or garden suites. **(16/2013)**

**14.2.0 LIST OF PERMITTED AND DISCRETIONARY USES**

14.2.1 PERMITTED USES

Dwellings, Single-Detached  
Dwellings, Semi-Detached  
Duplexes  
Home-Based Businesses, Minor  
Parks  
Playgrounds  
Roof Mounted Solar System **(19/2016)**  
Sales/Lot Information Centres  
Show Homes  
Signs as listed in Table 36.3.1

14.2.2 DISCRETIONARY USES

Accessory Buildings  
Accessory Suites  
Accessory Uses  
Antenna Structures  
Bed and Breakfast Accommodations  
Child Care Services  
Garden Suites  
Ground Mounted Solar System **(19/2016)**  
Home-Based Businesses, Major  
Pole Mounted Solar System **(19/2016)**  
Public and Quasi-Public Installations and Facilities  
Religious Institutions  
Signs as listed in Table 36.3.1  
Small Wind Turbine Type B **(19/2016)**  
Street Oriented Townhomes **(16/2013)**

**14.3.0 MINIMUM REQUIREMENTS**

14.3.1 LOT AREA

- a) Dwellings, Single-Detached: 300.00 m<sup>2</sup>;
- b) Duplexes: 450.00 m<sup>2</sup>;
- c) Dwellings, Semi-Detached:
  - (i) Except as in Section 14.3.1(c)(ii), 250.00 m<sup>2</sup> for each dwelling unit;

- (ii) 300.00 m<sup>2</sup> for each dwelling unit with a side yard abutting a street;
- d) Street Oriented Townhomes: **(16/2013)**
  - (i) 670.00 m<sup>2</sup> – condomization
  - (ii) 240.00 m<sup>2</sup> – outside unit, fee simple
  - (iii) 190.00 m<sup>2</sup> – inside unit, fee simple
- e) All Other Uses: At the discretion of the Development Authority.

14.3.2

LOT WIDTH

- a) Dwellings, Single-Detached, and Duplexes: 9.00 m;
- b) Dwellings, Semi-Detached:
  - (i) Except as in Section 14.3.2(b)(ii), 6.00 m for each dwelling unit;
  - (ii) 9.00 m for each unit with a side yard abutting a street;
- c) Street Oriented Townhomes: **(16/2013)**
  - (i) Except as in Section 14.3.2(c)(iii), 7.20 m for each outside unit;
  - (ii) Inside unit: 5.70 m;
  - (iii) 8.70 m for each unit outside unit with a side yard abutting a street;
- d) All Other Uses: At the discretion of the Development Authority.

14.3.3

FRONT YARD

4.00 m **(16/2013)**

14.3.4

SIDE YARDS - LANED LOTS

- a) Principal Buildings:
  - (i) Street Side of Corner Lot: 3.00 m;
  - (ii) All Other Lots: 1.20 m.
- b) Accessory Buildings:
  - (i) Street Side of Corner Lot: 3.00 m;
  - (ii) All Other Lots: 0.61 m.
- c) Street Oriented Townhomes: **(16/2013)**
  - (i) Street Side of Corner Lot: 3.00 m;
  - (ii) All other lots: 1.50 m;

14.3.5

SIDE YARDS - LANELESS LOTS

- a) Principal Buildings:
  - (i) With Attached Garages: 1.20 m;

- (ii) Without Attached Garages: one (1) unobstructed 3.00 m, the other 1.20 m;
  - (iii) Street Side of Corner Lot: 3.00 m;
  - (iv) Where a semi-detached building has been subdivided along the party wall, the side yard along the party wall: 0.00 m;
- b) Accessory Buildings:
- (i) Street Side of Corner Lot: 3.00 m;
  - (ii) All Other Lots: 0.61 m.

14.3.6

REAR YARD

- a) Principal Buildings: 7.50 m;
- b) Accessory Buildings: 1.20 m.

14.3.7

DRIVEWAYS

- a) Driveways must be a minimum 6.00 m in length measured from the front property line. **(16/2013)**

**14.4.0**

**MAXIMUM LIMITS**

14.4.1

BUILDING HEIGHTS

- a) Principal buildings: 12.00 m, except as provided in Sections 14.4.1 (b); **(16/2013)**
- b) Street Oriented Townhomes: maximum height is the lesser of: **(16/2013)**
  - (i) 13.00 m
  - (ii) The average building height of the two adjacent properties, plus 1.00 metre. If one of the adjacent properties is vacant, building height for the average calculation is assumed to be 12.00 m.
- c) Accessory Buildings: 5.50 m and one (1) storey, except as provided elsewhere in this Bylaw.

14.4.2

LOT COVERAGE

- a) Except as provided in Section 14.4.2(b) **(16/2013)**, all Residential Buildings (Principal and Accessory): 55%;
- b) Street Oriented Townhomes: 60% **(16/2013)**
- c) All Residential Accessory Buildings: 20%;
- d) All Other Uses: At the discretion of the Development Authority.

14.4.3

NUMBER OF DWELLING UNITS: 2, except as provided in Sections 12.2.0 and 12.3.0.



191043624

191043624 REGISTERED 2019 03 01  
CAVE - CAVEAT  
DOC 3 OF 3 DRR#: A0993BD ADR/CALHUTCH  
LINC/S: 0038098174 +